

RANGEHOOD & INSTALLATION GUIDE

# CL7272S

Revision V5.1

<b>1. Welcome</b>	3
<b>2. Your Safety</b>	
Safety Advice	4
Before Installation	5
Product Use	8
Maintenance and Service	8
Electrical Cord	8
<b>3. Tips and Suggestions</b>	
For Users	7
For Installers and Users	7
<b>4. Description</b>	
Main Rangehood	8
Speed Controls	8
<b>5. Operation</b>	
Control Panel	9
<b>6. Cleaning and Maintenance</b>	
Surfaces	10
Filters	10
Cleaning the Interior	11
Cleaning the Exterior	11
Replacing the Light Bulb	13
<b>7. Installation</b>	
Mounting Laws and Regulations	14
Wall Mount Installation	15
Installation Guide	16
BBQ Installation	17
Flexible Ducting	17
Isodrive Motor Setup	18
Overview	19
<b>8. Maintenance</b>	
Condensation Information	20
Troubleshooting	22
Technical Specifications	22
Faulty Installation	23
<b>9. Specification</b>	
CL7272S	24
<b>10. Disclaimer</b>	25

Thank you for purchasing your new Schweigen rangehood.

To get the maximum output from this unit, please thoroughly read this guide before installation and use.

The guide contains important information on the use and maintenance of the unit, as well as important safety notes. This will ensure your personal safety and the lasting value of your rangehood.

We trust that you will enjoy your new Schweigen rangehood.

Please always retain your proof of purchase to aid in any warranty queries.

If you are unable to locate your warranty card, one is available to download from our website **[www.schweigen.com.au](http://www.schweigen.com.au)**.

This appliance and its packaging are produced by processes that minimise waste and respect the environment.

Please help us to continue this effort to protect the environment by using the appliance efficiently and dispose of any packaging in a responsible manner.

<b>Model</b> .....
<b>Purchase Date</b> .....
<b>Purchase Location</b> .....



### WARNING

Please read this section thoroughly before attempting to operate the appliance. Inspect your product upon receipt. Any damage or defects **MUST** be reported within **48** hours, or no claim will be recognised.

#### **DO NOT INSTALL THIS APPLIANCE IF YOU FIND IT DAMAGED.**

If this product is installed damaged, neither the supplier, nor the retailer, will be responsible for the costs associated with the repair, replacement, removal or re-installation of the appliances.

1. There shall be adequate ventilation in the room when the rangehood is used at the same time as appliances burning gas or other fuels.
2. There is a fire risk if cleaning is not carried out in accordance with the instructions.
3. Do not flambé under the rangehood. This will damage the rangehood and will not be covered by warranty.
4. Do not ignite burners that give off intense, uncontrolled flames beneath the rangehood.
5. Make sure that no flames emerge from the sides of pans.
6. Do not leave packaging materials (bags, corner brackets, etc) within reach of children.
7. This appliance is not intended for use by person/s (including children) with reduced physical, sensory or mental capabilities, or lack of experience and/or knowledge. Unless the person has been given supervision or instruction concerning the use of the appliance by a person responsible for their safety. Children should be supervised to ensure that they do not play with the appliance, it is not a toy.
8. The air must not be discharged into a flue that is used for exhausting fumes from appliances burning gas or other fuels (not applicable to appliances that only discharge the air back into the room).
9. Accessible parts may become hot when used with cooking appliances.
10. Before performing any cleaning or maintenance operation, disconnect the rangehood from the mains using the respective mains or sector switch or by unplugging it.
11. Do not use the rangehood without the grease filters.
12. Keep the grease filters clean and respect the recommended cleaning frequencies.
13. Turn the rangehood motor on before starting to cook.
14. Turn the rangehood motor off about 10-15 minutes after you finish cooking.
15. It is forbidden to use the rangehood as an aspirator.
16. Never cook foodstuff directly over the flame or have the gas burners on under the rangehood without using cookware.

### Before Installation

1. We recommend this appliance be installed or repaired by a qualified Schweigen Home Appliances technician.
2. Please see our website [www.schweigen.com.au](http://www.schweigen.com.au) for recommended installers.
3. It is dangerous to modify any part of this appliance. Modification of any kind, will immediately void the warranty.
4. The manufacturer declines all responsibility in case of failure to adopt proper safety measures.
5. Ensure that the location in which this appliance is installed, has good and permanent ventilation.
6. Please consult local laws and regulations and install in accordance.
7. Use an electrical connector with earth that is correct for your location.
8. Check that the voltage in your area corresponds to the appliance as indicated on the rating label.
9. This appliance must be connected to an electricity supply with a **ground connection**.
10. Check that the installation and electrical connections are made by a qualified technician and that the indicated instructions and local regulations in force are met, using materials that are compliant with the applicable legislation.
11. The company will not be responsible for installations executed by non-qualified staff and installations that fail to heed the applicable legislation on electrical safety (with regard to both modes and materials).
12. The electrical technical data can be found inside the rangehood, after removing the grease filters.
13. The flexible power cable supplied is already connected internally and emerges from the rangehood near the air outlet tube.
14. **Before installing the electrical connections, you should:**
  - Verify that the indicated electrical data coincide with the voltage values and frequency of the electrical circuit in the house where the rangehood is to be installed;
  - Check that the premises has electrical protection against short circuits and electrocution, pursuant to the applicable legislation;
  - Always switch off the current using the double-pole switch before maintenance and turn the power on again for normal use only when the operation has been completed.

## 2. Your Safety

### Product Use

This product is designed for household use and should not be used for commercial applications.

After use, always ensure that all controls are in the “OFF” position.

When frying with a gas flame, take particular care not to allow the oil or grease in the pan to catch fire. (Flambé)

### Maintenance and Service

The rangehood surface should be cleaned with soft cloth and non-corrosive detergent. Do not leave the rangehood wet after cleaning or use, please keep rangehood dry.

**IMPORTANT:** Never attempt to repair this appliance by yourself. Always refer to a qualified Service Technician.

Always switch off the electricity and unplug the connection before conducting maintenance or cleaning.

### Electrical Cord

Ensure the supply cord is not exposed to heat, chemicals or sharp objects. If the supply cord is damaged, it must be replaced by the manufacturer, service agent or a similarly qualified person in order to avoid a hazard.

The Rangehood has one mode of operation:

**Air extraction:** The air is drawn in and cleaned by the grease filters and directed outside. Please check the cleaning and maintenance section for the filters' cleaning periods.

### For Users

1. Do not leave the frying pan or fryer unattended, as the oil could overheat and catch fire.
2. Never flambé any foods beneath the rangehood. The flames could cause a fire.
3. Before carrying out any operation inside the rangehood, unplug the appliance from the electrical mains.
4. Respect the cleaning frequencies and intervals for changing the filters, as otherwise the accumulated grease could cause a fire or damage the product.
5. Changes made to the steel surface will render the warranty invalid.

### For Installers and Users

1. In addition to the size, the height of the rangehood above the cooktop is important to obtain the best performance.
2. For recommended height, please refer to Mounting Laws and Regulations.

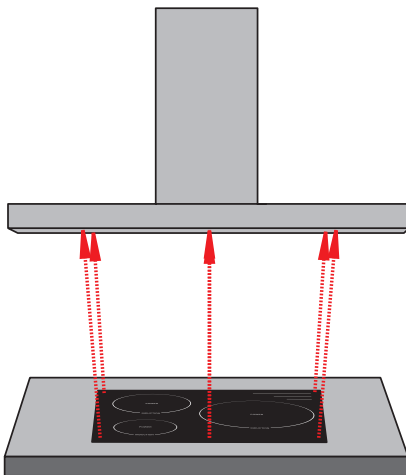

#### OPTIMAL

Rangehood bigger than the cooking area.

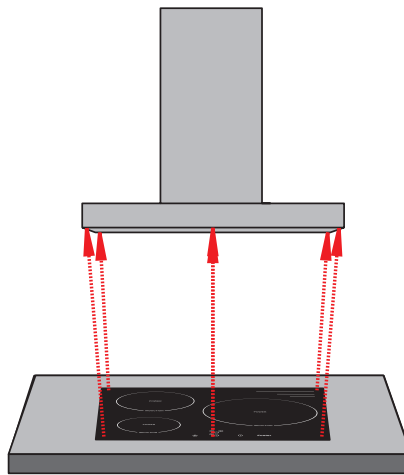

#### ADEQUATE

Rangehood equal to the cooking area.

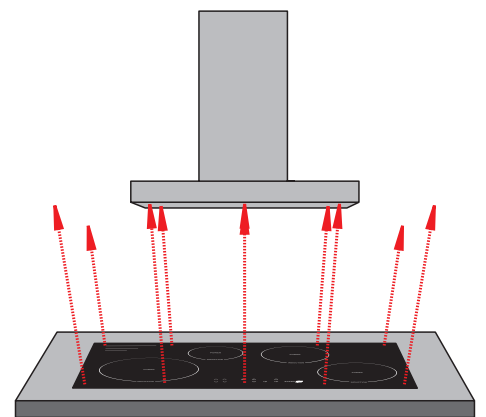

#### INADEQUATE

Rangehood smaller than the cooking area.

## 4. Description

### Main Rangehood

- ① Wall Mounting Bracket for section 2
- ② Extension Flue
- ③ Main Flue
- ④ For use with Isodrive motor system
- ⑤ Male Plug (Main Power 240V)  
Used for silent and non silent models
- ⑥ Two 200mm Outlets
- ⑦ Filters
- ⑧ Lamp (For GU10 fittings, please twist to remove)

**NOTE:** Filter and light quantity may vary from model to model.

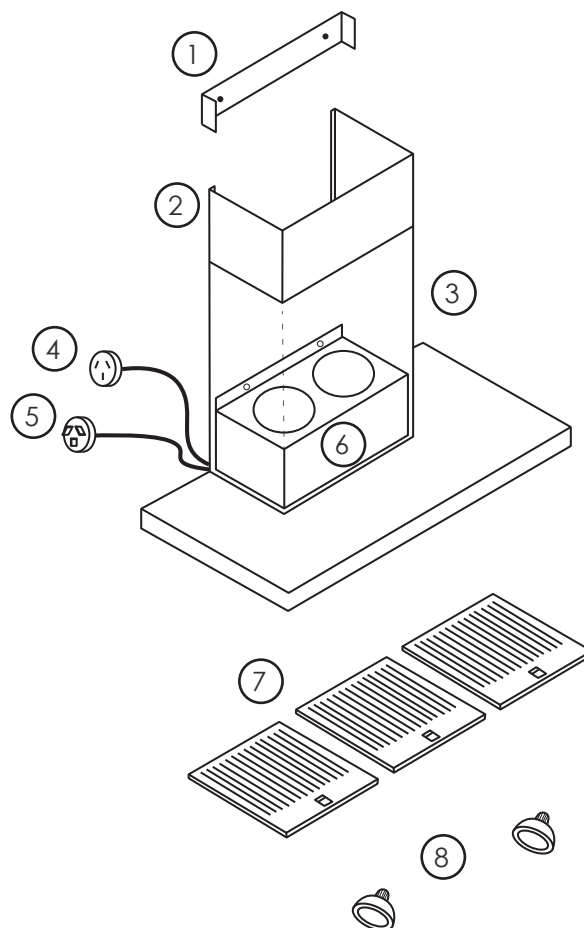

### Speed Control

This rangehood is equipped with a 3 speed mechanical control.

Speed control usage suggestions:





- Low speed for simmering.
- Medium speed for light cooking.
- High speed for heavy frying or heavy cooking.



Schweigen silent rangehoods are recognised for their silent operation. Although this holds true for all of our rangehoods with external motors, one must note that the rangehoods are silent when they are used for regular cooking on the lower fan setting. Therefore, you will only hear the movement of air.

## Push Button Control Panel



-  Turn on/off the rangehood
-  High speed setting
-  Medium speed setting
-  Low speed setting
-  Turn on/off the lamp

## 6. Cleaning & Maintenance



### WARNING

Always switch off and disconnect power before cleaning.

## Surfaces

Wash with warm soapy water and a soft sponge. Never use abrasive detergent, scouring pads, steel wool or solvents on any part of this appliance. Always make sure to dry the appliance after cleaning and never leave wet, as this will cause irreparable damage.

## Filters

- For this appliance to function effectively, regular maintenance is a must.
- The function of the filter is to absorb the grease particles emitted during cooking.
- Blocked filters and heavy oil deposits restrict airflow and may cause the motor to overheat and become a fire hazard.
- Filters should be cleaned every 3-6 weeks or after 40 hours of use.
- Disconnect the electrical connection before any maintenance or cleaning processes are carried out.
- To remove the filter pull the clip gently down until it disengages. To replace, perform the same operation but in reverse, making sure the back two tabs of the filter are lined up with the rangehood.
- In ceiling-mounted rangehoods, the doors or glass must be opened before accessing the filters.
- For an induction cooktop, please aim to clean them at least every 10 days, depending on use.
- The filters can be washed by hand or in the dishwasher

**Washing by hand** - Immerse the filter in hot water and a suitable detergent and when clean, rinse with plenty of hot water.

**Dishwasher** - Put the filter in the dishwasher and select a short program at low temperature.

**NOTE:** The colour of the metal mesh filters may change after several washes. This is normal and it is not necessary to change the filters.

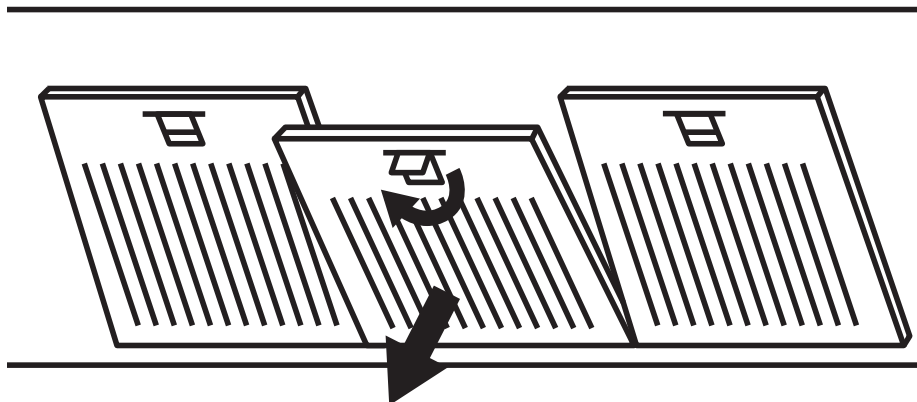



### **WARNING**

- If the grease filters are very dirty, the motor will extract only a small quantity of air, which reduces its efficiency;
- The grease deposits that build up on the filter are highly flammable and **COULD EASILY CATCH FIRE.**
- The manufacturer is exonerated from all responsibility in the event of fire due to poor maintenance of the grease filters.

### **Cleaning the Interior**

Clean the interior of the rangehood with a damp cloth and a neutral detergent or denatured alcohol.

**NOTE:** Do not use denatured alcohol on the exterior of the rangehood. Do not clean the electric parts or the motor with liquids or solvents

## 6. Cleaning & Maintenance

### Cleaning the Exterior

We recommended using a soft cloth, warm water and a liquid soap to clean the exterior. Rinse with clean water and ensure that the appliance is completely dry after cleaning. For better results, you can use high quality cleaning and protection products (eg. Steel Kleen) to clean your rangehood.



#### WARNING

- Make sure that the electrical power is off.
- The recommended detergent is a solution of water and a neutral liquid soap.
- It is very important for the liquid soap to not contain granules that could scratch the surface.
- First apply the solution to a soft cloth and then rub the cloth over the rangehood. It is important to follow the direction of the stained surface with the cloth (refer to figure on left).
- Do not pour any liquid directly on to the rangehood.
- The cloth must have no buttons, zips or fasteners that could scratch the surface.
- It is strictly forbidden to use chemical solvents, aggressive, grainy or abrasive products, naphtha, alcohol or similar products that could damage the surface of the rangehood.
- The manufacturer will not be held responsible for functional or aesthetic damage caused by cleaning with products which are not suitable or using inadequate cleaning methods.

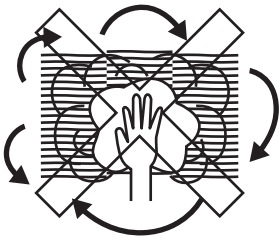

### Replacing the Light Bulb



#### **DANGER**

Always switch off and disconnect the power cord before replacing any light bulbs. Failure to do so may cause serious injury. Please be aware that the light bulb will retain heat for a short period of time after being switched off.

#### **Step 1**

Remove the filters from the rangehood.

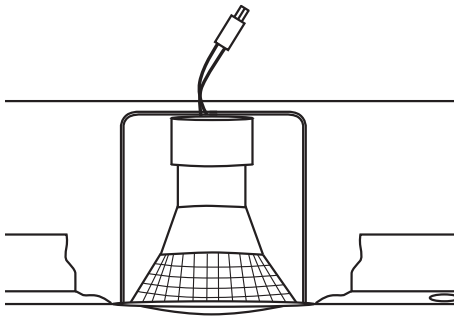

#### **Step 2**

Gently turn light bulb anti-clockwise, pull the light bulb down and remove it from the light holder.

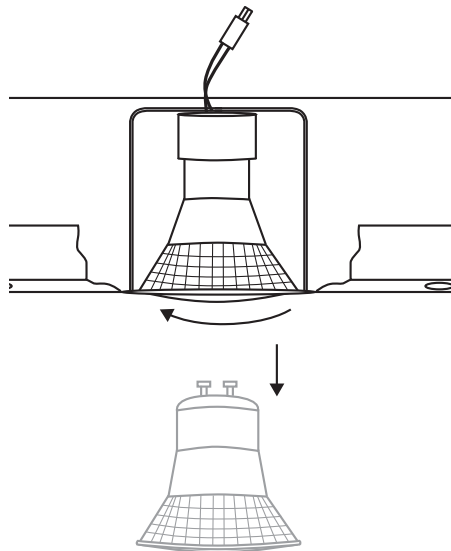

#### **Step 3**

Insert a new light bulb by lining up the pins of the light bulb with the larger holes inside the light holder. Once the pins are in place, turn clockwise to secure the light bulb.

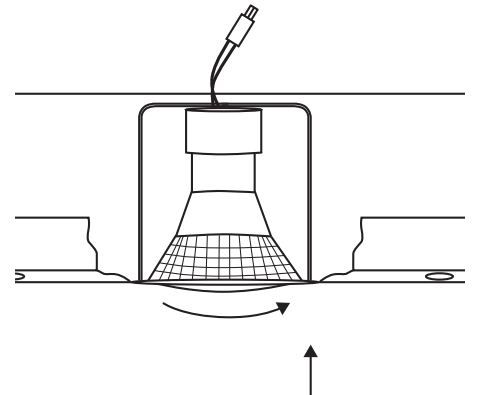

## 7. Installation



### **DANGER**

Always switch off and disconnect power before installing the rangehood. Failure to do so may cause serious injury.

**\*IMPORTANT: Please check all State and Federal Laws in relation to the minimum - maximum heights, regulations concerning the expelling of air and install your rangehood in accordance with local laws and regulations.**

## Mounting Laws and Regulations

To be installed in an undercover alfresco area and/or indoor kitchen only. If the unit is not adequately covered or sheltered from the outside elements the warranty will be null and void.

The rangehood must be located at the correct distance from the work plane.

### **Outdoor Alfresco Area**

- Minimum height 800mm\*
- Maximum height 1200mm\*

### **For indoor kitchen area:**

The minimum safety installation distance between the top of a cooktop and the lowest part of the rangehood are as follows:

**Minimum installation height for electric and gas cooktops is 650mm\*.**

**For rangehoods 90cm wide or larger:** Distances above 800mm can compromise the extraction performance.

**For 60cm wide rangehoods:** Distances above 750mm can compromise the extraction performance.

**Suggested height above a Induction Cook top is 720mm to 800mm.** For more information please see section Maintenance - Condensation Information\*.

The location of the installation must have permanent openings for ventilation.

Regulations concerning the expelling of air have to be fulfilled.

It is strongly recommended that the rangehood be installed centrally over the cooktop.

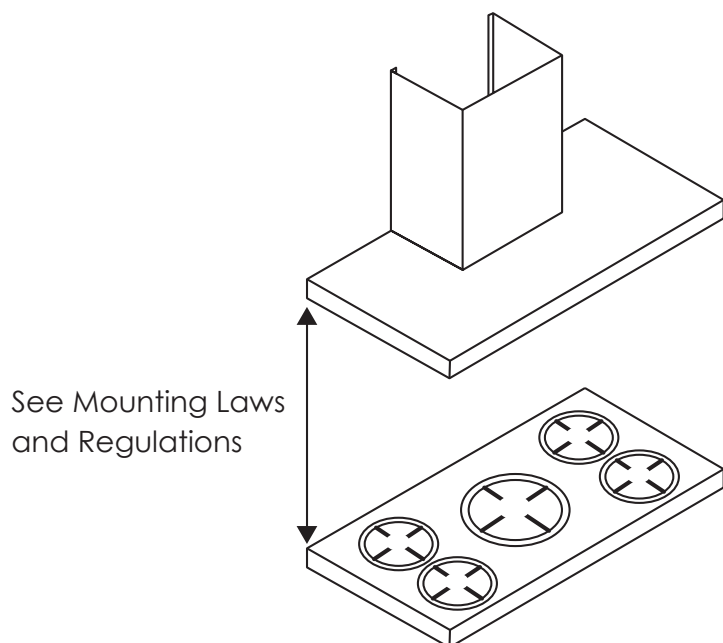

## WARNING

If the user decides to install the rangehood at a distance of less than minimum height above the cooking surface, the company declines responsibility for damages suffered by the rangehood due to excess heat or damage to objects, people and others caused directly or indirectly by a malfunction, breakage or fire.

## Wall Mount Installation

Every wall mounted rangehood has two primary mounting points and several secondary mounting points to firmly fix the rangehood in its place.

**NOTE:** The position of the secondary mounting holes may vary.

Please ensure that the holes for the two primary mounting points are level before installation.



## DANGER

Always switch off and disconnect power before installing the rangehood. Failure to do so may cause serious injury.

Primary mounting points\*

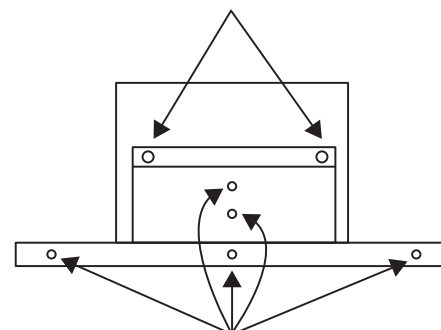

Secondary mounting points\*

**\*Note:** Picture is for illustration purposes only. The actual product may have different mounting points position.

## 7. Installation

### Step 1

Secure rangehood to the wall using the primary mounting points. Check the level of the rangehood and adjust accordingly if necessary. Once level, continue to secure the rangehood via the secondary mounting points.

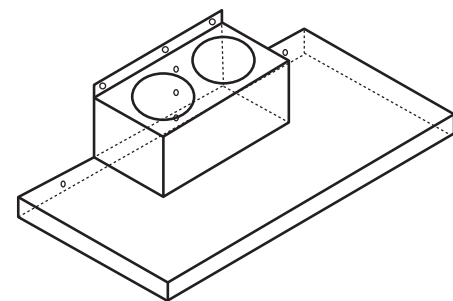

### Step 2

Feed the aluminium flexi duct from the outlet block to the kitchen ceiling. Attaching ducting using either zip tie or duct tape.

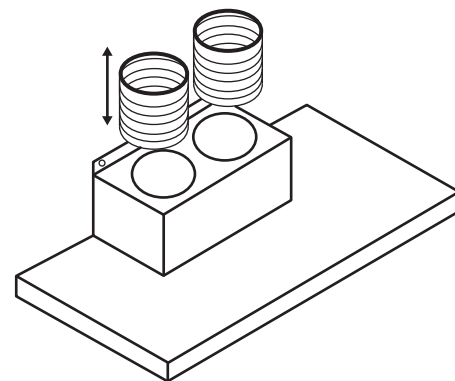

### Step 3

Place flue covers on, make sure the flue sits in the well.

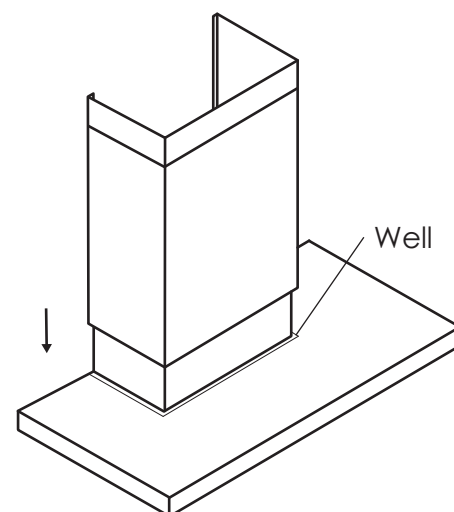

### Step 4

Attach inside flue cover to the wall mounting bracket. The wall mounting bracket determines the height of the internal flue section.

**IMPORTANT:** Please make sure that all plastic protection on the rangehood and filters are removed before use.

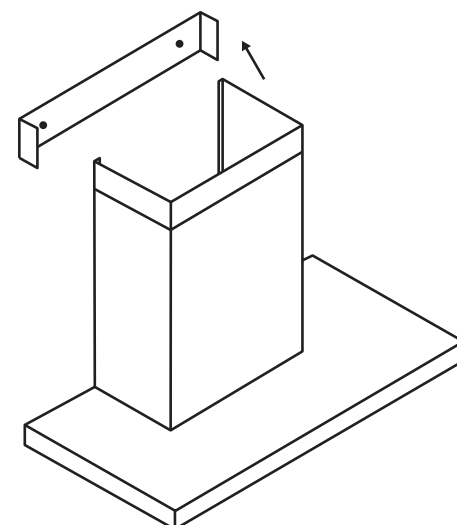



## BBQ Installation

When installing the rangehood over a BBQ, please be aware that the lid will obstruct the rangehood's effectiveness to extract smoke, steam and odours. Where possible, remove the lid of the BBQ unit when in use to allow for effective rangehood extraction.

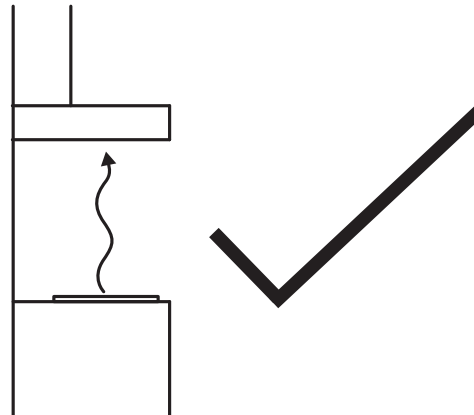
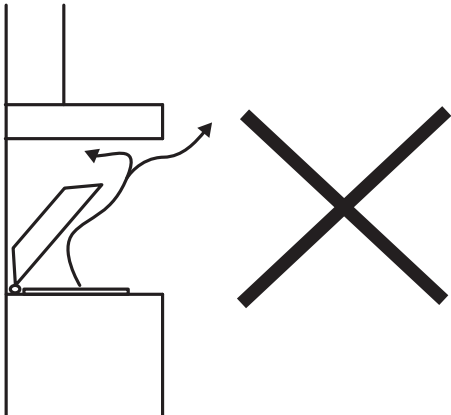

## Flexible Ducting

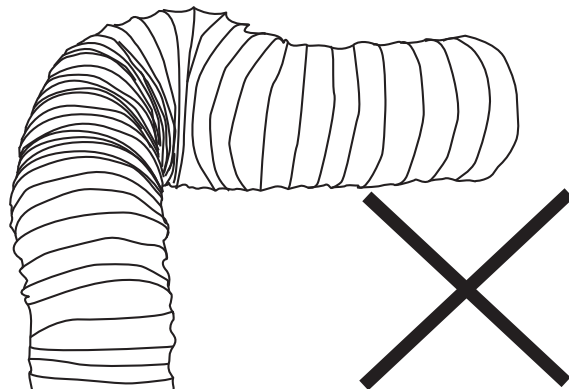
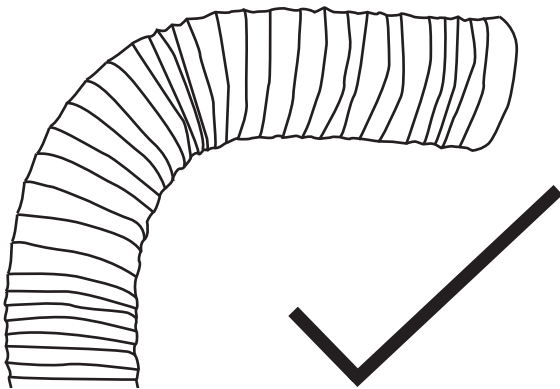

For the Isodrive motors, please do not crush or kink any of the flexi ducting, this will reduce the air flow and may cause noise throughout the system. Ducting needs to be kept taut at all times.

**Please refer to the Isodrive motor installation guide for more details on flexi ducting with the silent system.**

### Isodrive Motor Setup

#### IMPORTANT

Please remove the clip when attaching Isodrive 1600 / 3200 motor (Single or Twin) system. To remove the clip, hold down 1, 2 and 3 gently pull out to direction 4.

**NOTE: DO NOT REMOVE** the clip at the end of the white cord when installing an Isodrive 650 / 900 motor (Single or Twin) system.

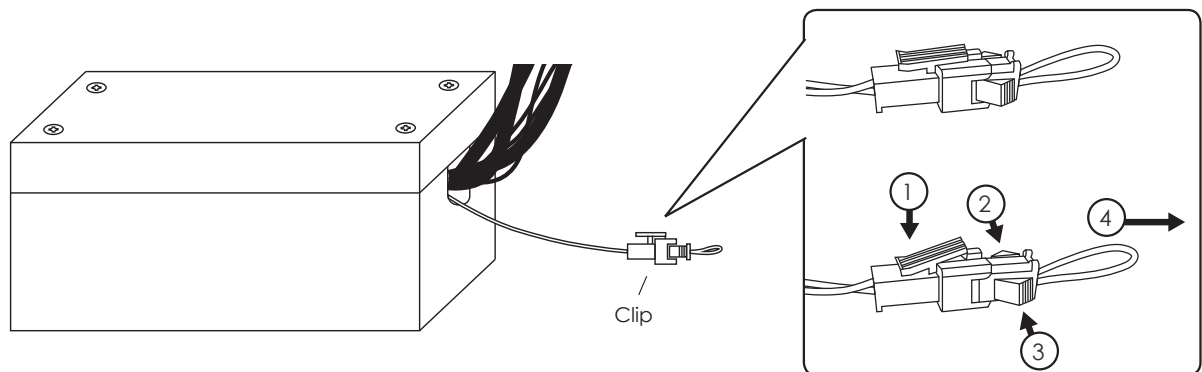

For technical support, please contact **1300 829 066**.

## Overview

**WARNING**

All electrical wiring (for connection from motor to rangehood) should be kept inside the roof space.

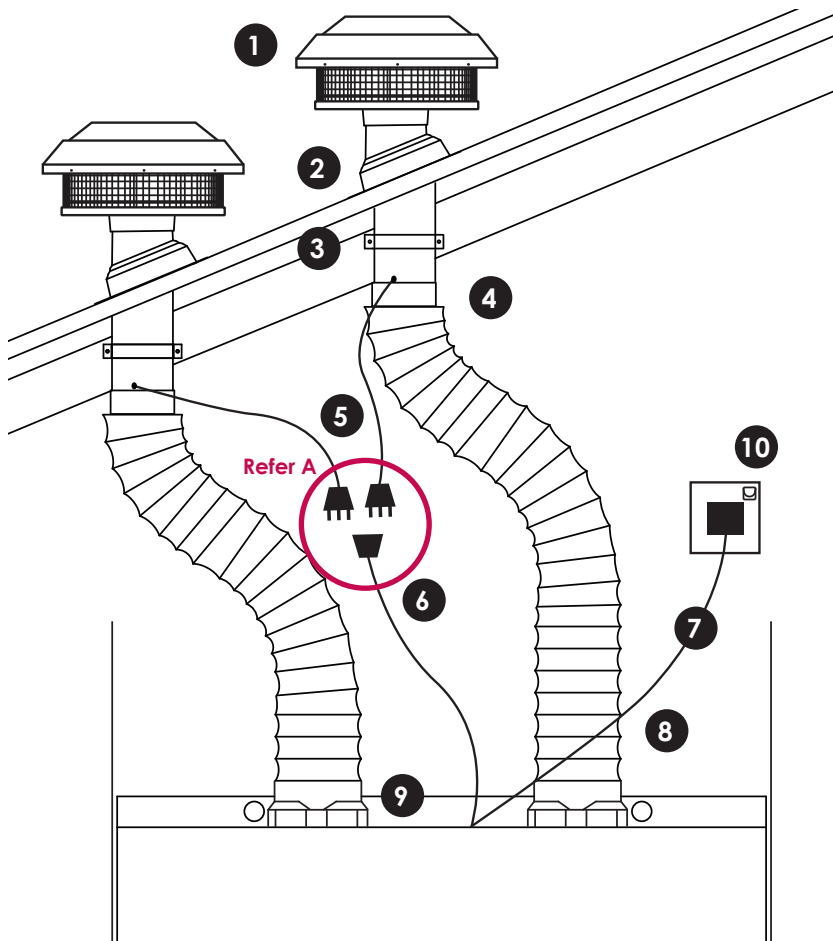

- ① Isodrive Motor
- ② Roof Seal Kit (Dektite)\*
- ③ Support Straps\*
- ④ Attach Flexi Duct to Bell-Mouth Adaptor using duct tape and cable tie. Please **DO NOT** rip the ducting.
- ⑤ Motor Power Lead (Male Plug)
- ⑥ Rangehood to Motor Lead (Female Plug)
- ⑦ Main Power Lead (Male Plug)
- ⑧ Flexi Ducting must be pulled taut. **DO NOT** crush or kink the ducting.
- ⑨ Connect flexi ducting to the outlet on rangehood using duct tape or cable tie. Please **DO NOT** rip the ducting.
- ⑩ Powerpoint should be located in an accessible area.

**\*NOTE:** The Isodrive motor system does not include the roof seal kit, cable tie, duct tape or the support straps. The weather shield is only available for the Isodrive 1600 motor and needs to be attached directly to the motor (1).

**A:** Connect them with a high quality double adaptor or hard wired them together by an electrician.

This picture is for illustrative purposes only, not to scale.

### Condensation Information

The induction cooktop is designed to provide rapid heating, improved thermal efficiency and greater heat consistency. For some customers with an induction cooktop, condensation can form on their rangehood filters while using their cooktop.

The induction cooktops' heat source is contained in the conductive base of the pot. When compared with a gas, electric or wok burner, the heat is not isolated or contained to one area and therefore gradually rises up on all sides of the pot or frypan. This combination allows the rangehood filters to warm up slowly and eliminate the formation of condensation. For induction cooktops, the immediate and contained heat source can produce vapours rapidly. This prevents the filters from gradually warming up and increases the chance of condensation forming.

There are many variables that can contribute to the condensation problem associated with induction cooktops and rangehoods. Some of these variables include, but are not limited to:

- The Country or State you live in (example, WA versus VIC, and the variables in daily temperatures)
- The position of your home and kitchen (morning/afternoon sun)
- The quality of pots and cookware you are using
- Height of rangehood
- Rapid heating
- Ducting angle
- Filter size

**If induction, vitro-ceramic hobs** and the like are not used correctly, they can lead to problems with the condensation of liquids due to temperature differences. After some time in use, these condensed liquids can build up and possibly appear on the metal filters or the bottom of the rangehood.

For advice to avoid condensation, please refer to next page.

### **User advice to avoid condensation in the rangehood:**

- The rangehood should be switched on approx. 10 minutes prior to cooking and the delay shut down timer set after cooking has stopped in order to clear the fumes held in the flue. These steps will help clear the flue out fully.
- Do not cook at full power straight away, i.e. start on low or medium power for a while so that the steel in the rangehood can warm up.
- Filters must be kept clean. For induction cooktop users, aim to clean filters at least every 10 days, and replace the filters if their condition begins to deteriorate.
- There must be a constant flow of air into the cooking area to avoid the creation of a depression which can affect the rate of aspiration.
- Follow the advice from the instructions for induction systems with regards to the condensation effect.
- Suggested height for induction cooktop is approx. 750mm above the cooking surface.

Each person's circumstances are different, but the vast majority of induction cooktop owners have had no problems with condensation. However, it is important to understand that:

Neither the rangehood nor the induction cooktop are faulty. That in some circumstances, the combination of the rangehood, the induction cooktop and the many variables within your home, can lead to condensation forming on your rangehood filters. With a gas or standard electric cooktop, you should not have any condensation.

## 8. Maintenance

### Troubleshooting

#### If the product does not work:

Before you contact the technical service department, make sure that the product is plugged in, the electric fuse (on selected models) is in correctly and electric wiring is connected. (Fuses can be purchased from your local electrical dealer or hardware store). Weak air suction may be caused by back draft fins remaining closed. Do not take any action that will damage the product.

	Check electric connection. Voltage of the electric network should be between 220 - 240V, rangehood should be connected to grounded plug and turned on.	Check motor switch. Please ensure that there is power to the rangehood and the rangehood is switched on.	Check lamp switch. Lamp switch should be at on position.	Check metal filter. Metal filter should be washed regularly, see filter cleaning.	Check lamps. Lamps should be firm.	Check outlet. Outlet should be open.	Check lamps and fuse. Make sure they are not broken or faulty.	Please make sure there is no obstruction in ducting or back draft fins.	Check the outlet, make sure it is not blocked and you have the correct diameter ducting installed.	Check Isodrive installation manual, make sure the flexi ducting is installed correctly, eg. Length of ducting used, keep the ducting taut.
Rangehood does not work	X	X								
Light does not work	X		X		X		X			
Rangehood air suction is weak				X		X		X	X	
Rangehood does not direct air out (through chimney)				X				X		
Loud noise from the rangehood									X	

### Technical Specifications

<b>Model</b>	CL7272S
<b>Feeding Voltage</b>	220-240V 50Hz
<b>Lamp Power — Halogen (W)</b>	4 x 35W (supplied)
<b>Lamp Power — LED (W)</b>	4 x 1.8-7W (optional)

### Calling the Technical Assistance Service Hotline

In the event that the failure is not due to the faults mentioned in Trouble Shooting, contact the Technical Service 1300 829 066.

A service request will require the following information:

- The purchase date
- The rangehood model and motor type (eg. Isodrive 650)
- The rangehood serial number or batch number (this number is on a sticker inside the rangehood)

### Faulty Installation

It is not the responsibility of Schweigen Home Appliances to rectify any incorrect installations. A service call out fee will be charged for any Schweigen technician that attends a call, whereby it's established that the fault is due to an incorrect installation or non-manufacturing fault. Should the appliance be installed in such a way that the service agent is unable to gain access to the appliance, the person/s who own the premises or the appliance where the appliance resides — will be responsible to provide access to the appliance at their expense.

# 9. Specification

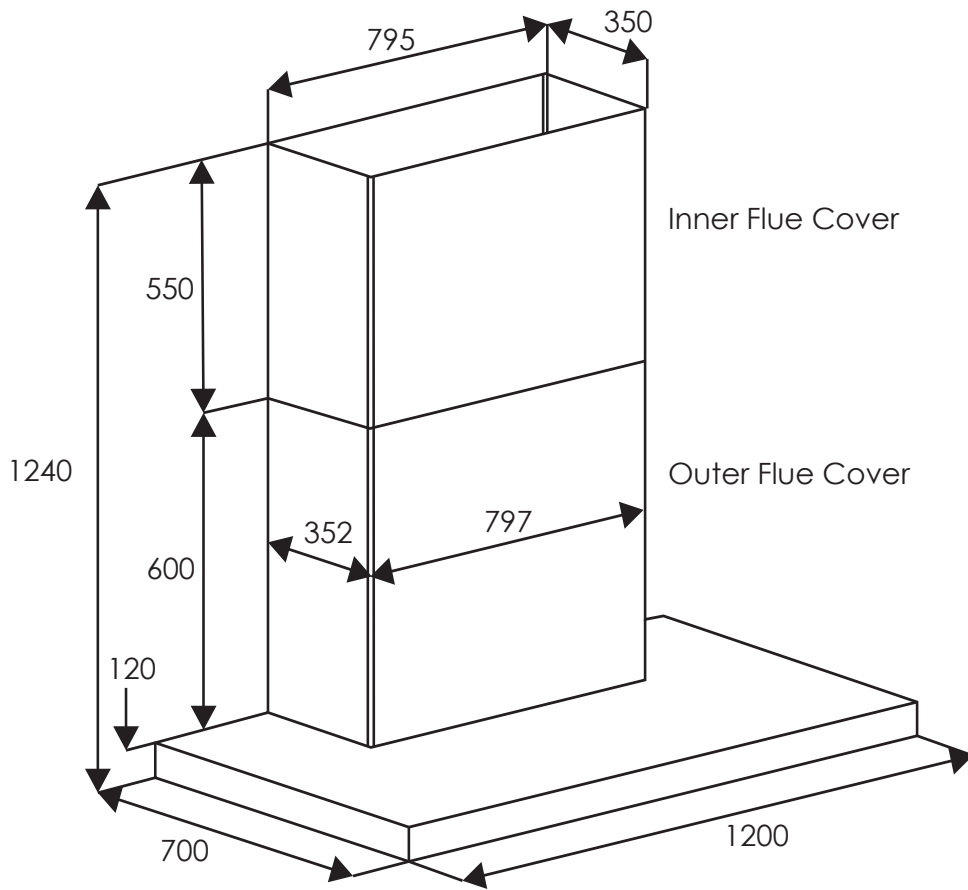
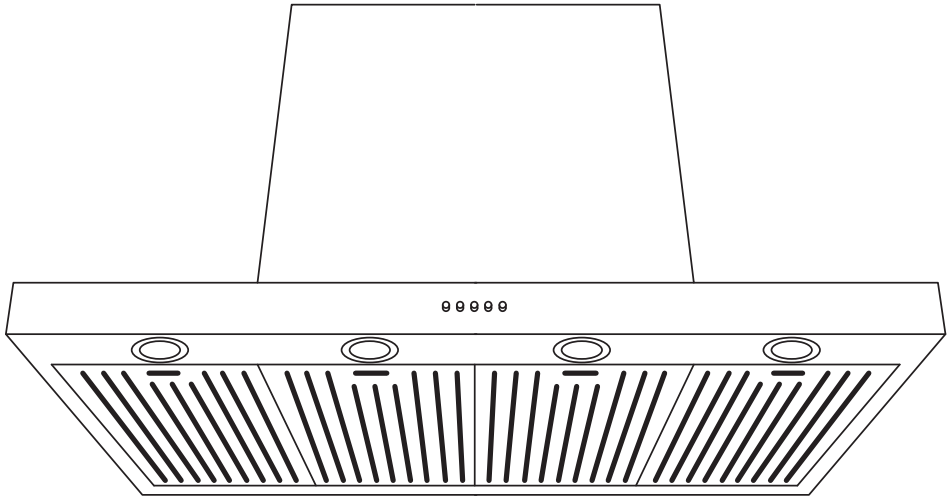



Under our policy of continuous product development, product specifications may change without notice. Prospective purchasers should therefore check with the retailer to ensure this publication correctly describes the products being offered for sale. All information supplied is to be used for general reference purposes only and is on the understanding that Schweigen Home Appliances will not be liable for any loss, liability or damage of whatever kind arising as a result of any reliance upon such information. All pictures used in the guide are for illustrative purposes only.

Although our information and marketing states the term 'Silent' for certain models, the following applies to various models that are sold with the IsoDrive System. When a model with the larger motored IsoDrive System is operated at the higher speed/s air movement may be heard. For example, while operating on speed 4 & 5 (For 5 speed models) the rangehood can be audible due to the large amount of air movement.

\*Please make sure that the rangehood and motor have been installed as per the instruction guides in order for optimal performance.

Schweigen Home Appliances has presented this information in good faith to all their retailers and distributors to convey before any/all purchase/s. Information is supplied upon the condition that the person/s receiving the information will make their own determination as to its suitability for their purpose/s prior to use. In no event will Schweigen Home Appliances be responsible for damages of any nature whatsoever resulting from the use of, or reliance upon, information from their website or the products to which the information refers.

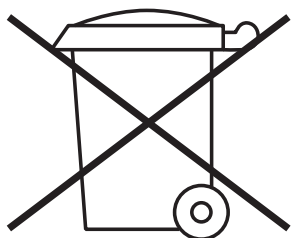

The symbol on the product or its packaging indicates that it cannot be treated as normal household waste. Take this product to your nearest electrical and electronic equipment waste point for recycling. By correctly disposing of this product, you will be helping to prevent potentially negative consequences for the environment and public health, which could arise if this product is not handled in the appropriate way. For more details about the recycling of this product please contact the authorities of your city or town, your local household waste service or the store where you purchased the product.





# schweigen

HOME APPLIANCES

Distributed by: Unit 102/45 Gilby Road,  
Mt Waverley 3149 Victoria.



**1300 881 693 (EST)**

**[www.schweigen.com.au](http://www.schweigen.com.au)**